

ZARF30105-TV

Needle roller/axial cylindrical roller bearing

Schaeffler ID:
0016827920000

Needle roller/axial cylindrical roller bearings ZARF, double direction, for screw mounting

Technical information

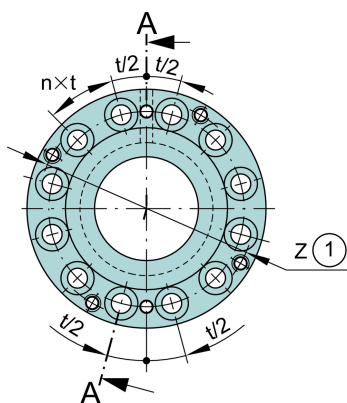
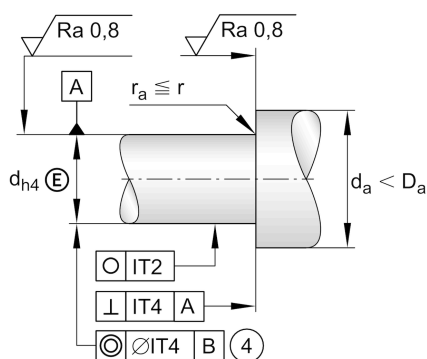
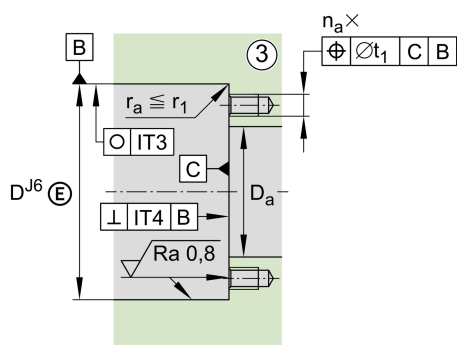

Main Dimensions & Performance Data

d	30 mm	Bore diameter
D	105 mm	Outside diameter
H	66 mm	Height
C _r	26,000 N	Basic dynamic load rating, radial
C _{0r}	47,000 N	Basic static load rating, radial
C _a	107,000 N	Basic dynamic load rating, axial
C _{0a}	265,000 N	Basic static load rating, axial
C _{ur}	6,800 N	Fatigue load limit, radial
C _{ua}	22,900 N	Fatigue load limit, axial
n _{G Grease}	1,300 1/min	Limiting speed for grease lubrication
n _{G Oil}	4,400 1/min	Limiting speed for oil lubrication
M _{RL}	2.1 Nm	Bearing friction torque
	1.81 kg	Weight

Dimensions

H ₁	41 mm	Height outer ring over wave washer
c _{aL}	3,300 N/μm	Rigidity axial
c _{kL}	1,100 Nm/mrad	Tilting stiffness
C	18 mm	Width, outer ring
	1 μm	Axial runout
C ₁	10 mm	Distance to lubrication hole
D ₁	68 mm	Rip diameter shaft washer
M _A	75 Nm	Tightening torque nut
	24,287 N	Preload force axial
B	14 mm	Width, inner ring
r _{min}	0.3 mm	Minimum chamfer dimension
r _{1 min}	0.6 mm	Minimum chamfer dimension
d ₁	3.2 mm	Diameter lubrication hole
J	85 mm	Pitch circle diameter (holes)
n x t	30 °	Split
t ₁	0.2 mm	Position bore in the housing

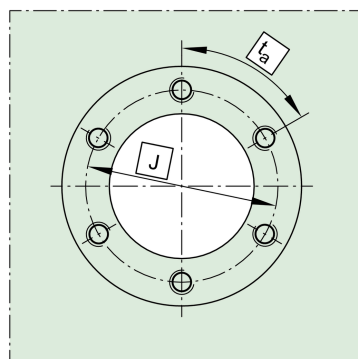
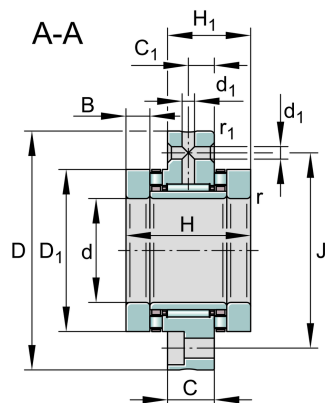

Mounting dimensions

$D_{a \max}$	69 mm	Maximum diameter of housing shoulder
$d_{a \min}$	52 mm	Minimum diameter shaft shoulder
	ZMA30/65	Locknut 1
	AM30	Locknut 2
n	12	Number (screwing holes)
	M8	Screw size
M_M	6.53 kg * cm ²	Mass moment of inertia
n	12	Number of screws
na x ta	30 °	Division (screwing holes)